

# The Core Family

Welcome to the Core line of cylinder fixtures. When plenum space is constrained or an open ceiling plan is deployed the round adjustable cylinder features 3 mounting options: Surface, Stem/Pendant and J-Box (for open ceiling applications). The J-box mounting comes with a crafted and finished J-box cover allowing conduit pass through. With 40 paint and anodize finish options available, the fixture deploys 360° of rotation and 90° of tilt to get the light moving to where you want it.

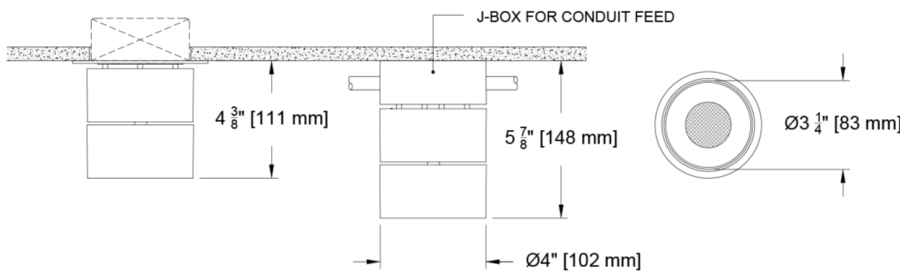

PROJECT:

TYPE:

SPECIFIER:

DATE:

## Key Points (CR4C-RA)

### Housing/Trim

- Heavy gauge extruded aluminum finished and machined in USA
- 3 Mounting options - Surface, Jbox or Stem/Pendant mount
- 40 finish options + custom and RAL available
- Adjustable - 360° rotation and 90° tilt
- Listed to UL standard 1598 - Damp Location

### Source/Optics

- Up to 940 delivered lumens
- source efficacy to JA8 requirements
- <2 MacAdam Ellipses (<2SDCM) for fixed white sources
- 90+ CRI, 60+ R9 standard, 95 CRI, 90+ R9 available in Ambient Dim
- 2400K, 2700K, 3000K, 3500K, 4000K Ambient Dim, RGBW & Tunable White options
- Beam options of 20°, 26°, 38° and 60°
- Lifetime: L87B3>55,000 hours at 40° C ambient for fixed white source

### Driver

- Universal 120v to 277v
- Prewired & integral to fixture. Remote available upon request
- Flicker free to IEEE 1789-2015
- Phase, 0-10, DALI-2, DMX, Ecosystem or Wireless control

## Finish Options - See finish guide for full spectrum of colors

### PXX- Powder Coat Paint examples



P14 White Paint



P13 Moog Bronze

### AXX- Anodize finish examples



A01 Blk Anodize



A26 Gold Anod.



A30 Red Anod.



A32 Clear Anodize

# Ordering Codes

PROJECT:

SPECIFIER:

DATE:

TYPE:

QUANTITY:

Ordering Code Example: CR4C-RA-JB-C14-30-38-C1-L07-91A-EM

FIXTURE	MOUNTING	LENGTH	SOURCE / WATTS	CCT	BEAM	DRIVER / CONTROL	HOUSING FINISH	LENS ACCESSORIES	ACCESSORIES
<b>CR4C-RA</b>									
Core 4" Round Adjustable Cylinder	<p>SM Surface Mount*</p> <p>SMR Surface Mount ^ (Remote driver)</p> <p>JB J Box mount^</p> <p>JBR J Box mount^ (Remote Driver)</p> <p>LJB Large Junction Box, accommodates Lutron &amp; EldoLED^</p> <p>STM Stem Mount</p> <p>*Recessed Jbox supplied by others</p> <p>^Surface Jbox cover crafted, finished and supplied by Specialty</p>	<p>B Blank - use for surface or jbox mount</p> <p>- Specify Length</p> <p>6 6" Stem</p> <p>12 12" Stem</p> <p>18 18" Stem</p> <p>24 24" Stem</p> <p>Note: All stems supplied by Specialty Lighting</p>	<p><b>Citizen</b></p> <p>C14 ●● 14W 940Lm* 90+CRI, 60+R9</p> <p><b>Tunable</b></p> <p>T9 90+CRI, 60+R9 Tunable White</p> <p>T14 90+CRI, 60+R9 Tunable White</p> <p><b>RGBW</b> 90+CRI, 60+R9</p> <p><b>Ambient Dim™</b></p> <p>A14 ●● 14W 831Lm* 95+CRI, 90+R9</p> <p>*Based on 20° Optic</p>	<p>24 2400K</p> <p>27 2700K</p> <p>30 3000K</p> <p>35 3500K</p> <p>40 4000K</p> <p><b>Tunable</b></p> <p>TW1840 1800-4000K Tunable White w/ E1, E2, E3, E4</p> <p>TW2765 2700-6500K Tunable White w/ E1, E2, E3, E4</p> <p>RG1280 1200-8000K RGBW Dynamic Color Changing *Requires E2 or E4</p> <p><b>Ambient Dim™</b></p> <p>2722 2700-2200K</p> <p>3019 3000-1900K</p> <p>3022 3000-2200K</p>	<p>20 Spot</p> <p>26 Narrow Flood</p> <p>38 Flood</p> <p>60 Wide Flood</p>	<p>C1 0-10 1.0%, UNV (120-277V) linear</p> <p>C2 ELV/Triac 1.0%, (120V) linear</p> <p>E1 0-10 0.1%, UNV (120-277V) log</p> <p>E2 DALI-2 0.1%, UNV (120-277V) log</p> <p>E3 0-10 0.1%, UNV (120-277V) linear</p> <p>E4^ DMX 0.1%, UNV (120-277V) Universal DMX Driver/Controller RGBW-DMX ^ INCLUDES DMX/RDM COMPATIBLE DRIVER WITH BUILT-IN DECODER - CONTROLLER BY OTHERS</p> <p>TR2 TruPhase™ 0.1%, (120-120V) log Up to 20W Forward and Reverse compatible Phase Dimming Static White &amp; Ambient Dim only</p> <p><b>Lutron</b></p> <p>LD Digital Ecosystem* 1.0%, UNV (120-277V) ECO Hi-Lume SoftOn/Fade-to-Black LDE1</p> <p>Note: EldoLED and Lutron drivers require the selection of LJB mounting.</p>	<p>W White Paint</p> <p>B Black Paint</p> <p>PXX Specialty Paint Color*</p> <p>P01-P15</p> <p>A01 Black Anodize</p> <p>A32 Clear Anodize</p> <p>AXX Specialty Anodize Color*</p> <p>A1-A36</p> <p>C Custom/RAL*</p> <p>*See Finish Guide</p>	<p>91A Solite</p> <p>Aperture Lens</p> <p>93A Frosted</p> <p>XXA Other Aperture Lens Treatments*</p> <p>91A Solite</p> <p>93A Frosted</p> <p>XXA Other Aperture Lens Treatments*</p>	<p>EM Emergency Pack</p> <p>Controls</p> <p>LR Lutron Wireless RF PowPak</p> <p>ATH Lutron Athena Wireless Node Must be used with E2 driver</p> <p>CA Casambi Wireless BLE to be paired with driver</p>



# Ceiling Cutouts and Dimensions

## Adjustable Downlight Surface Mount

(CR4C-RA-SM-)

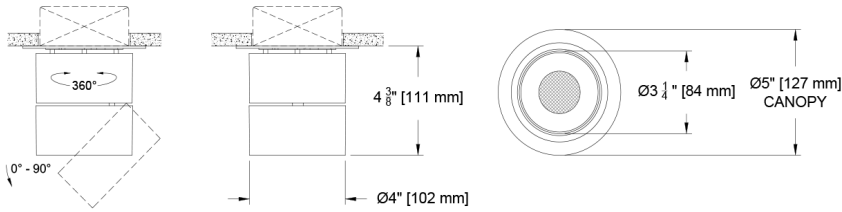

## Remote Driver Box For C1, C2, E1, E2, E3, TR2

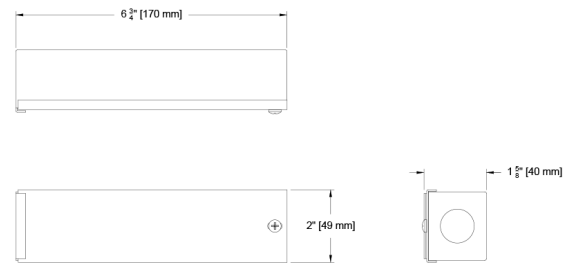

## Adjustable Downlight J-Box Mount

(CR4C-RA-JB-)

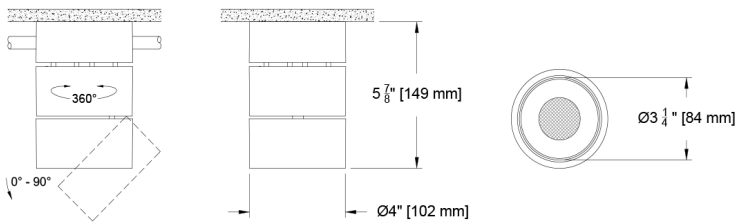

## Remote Driver Box E4, LD

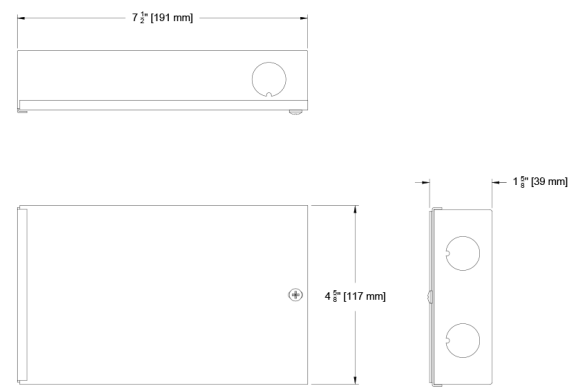

## Adjustable Downlight Large J-Box (for Lutron or EldoLED Driver)

(CR4C-RA-LJB-)

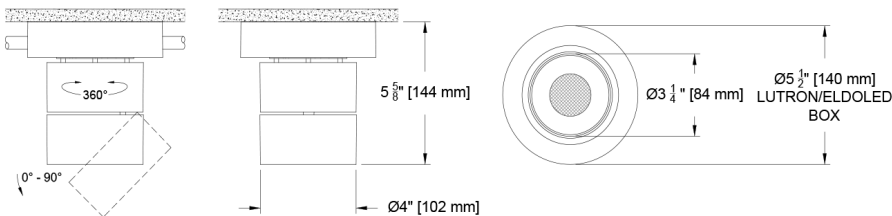

## Adjustable Downlight Stem / Pendant Mount

(CR4C-RA-STM-)

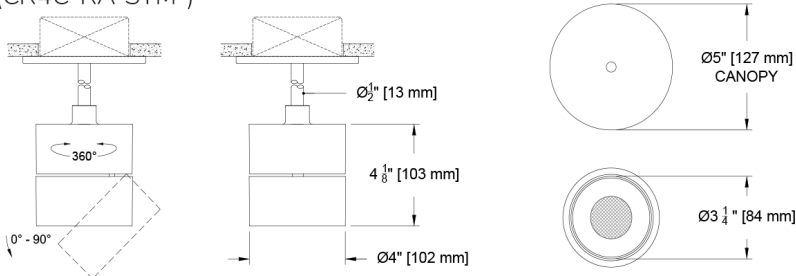

# Photometric Table

All data is based from goniometer measurements of production representative product. All lumen values can vary +/- 10% from LED manufacturer rated flux range. All measurements are delivered lumens based on 3000K unless otherwise noted below. Ambient dim measured at full output. ISO cd Plots based upon C14 Source.

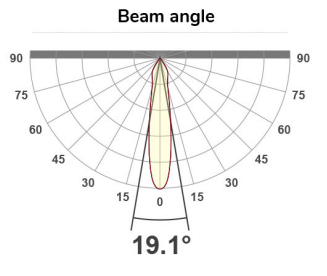
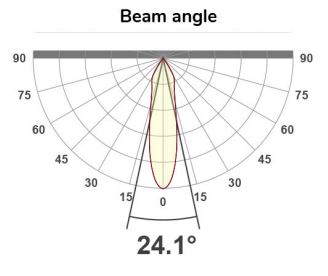
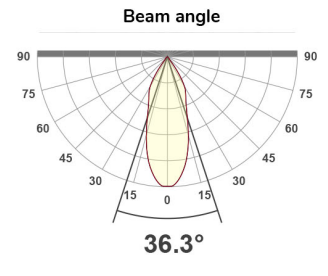
CYLINDER Beamspreads		20°				26°				38°			
Source	System watts (W)	Delivered Lumens (lm)	Lumens/ Watt	Peak CD	10% Field	Delivered Lumens (lm)	Lumens/ Watt	Peak CD	10% Field	Delivered Lumens (lm)	Lumens/ Watt	Peak CD	10% Field
Citizen C14	14	940	65	2529	70°	908	63	2102	71°	903	63	1456	75°
Ambient Dim A14	14	831	58	3063	65°	815	57	2328	68°	780	54	1449	73°
CCT Multiplier		 <p style="text-align: center;"><b>19.1°</b></p>				 <p style="text-align: center;"><b>24.1°</b></p>				 <p style="text-align: center;"><b>36.3°</b></p>			
CCT	Citizen												
2700	0.95												
3000	1.00												
3500	1.02												
4000	1.03												
<p>All measurements are delivered lumens based on 3000K unless otherwise noted below. Ambient Dim measured at full output. ISO CD plots based on A14 source. C14 source increases beam spread approximately 3° to 5°. All fixture efficacies are Title 24 compliant to JAB.</p>													

## Citizen Source C14

- <2 MacAdam Ellipse (<2 SDCM)
- 90+ CRI and RF
- 60+R9, Hue Bin 1

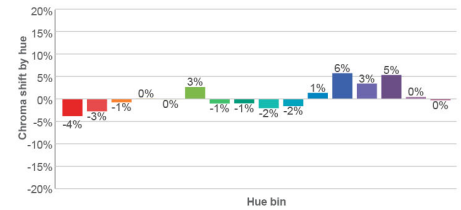
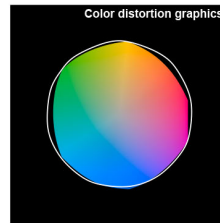
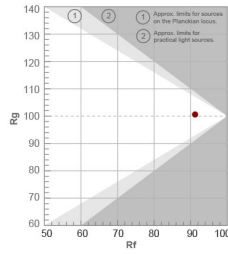
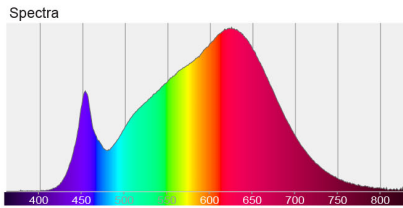
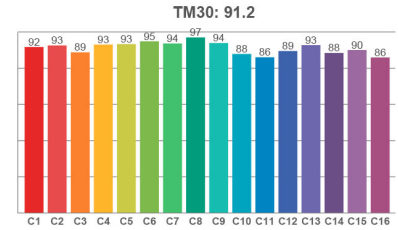
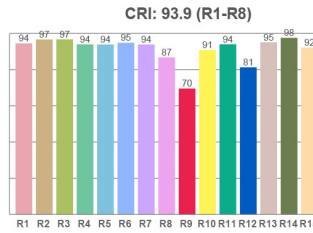
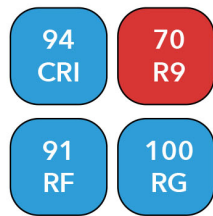

## Ambient Dim Source A14 (AD - 3000k to 1900k)

- <3 MacAdam Ellipse (<3 SDCM)
- 95+ CRI and RF
- 90+R9, Hue Bin 1
- Follows Black Body Locus through dimming range

### 3000 CCT Full Output

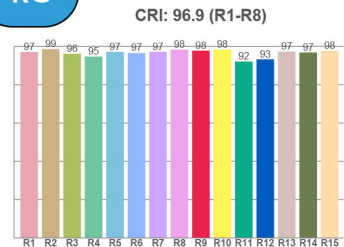
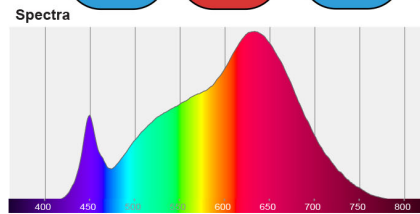

### 1850 CCT 5% Output

